

C470 cartridges are the **largest** ones of the JBC range. This range features many shapes, sizes and **special** models. Due to their size, these cartridges are appropriate for **intensive soldering** purposes and they are perfect for both **SMD** and applications with high power requirements. They work with **T470 Handpieces**. **JBC Long Life Tips** offer instant heat up, excellent heat transfer and great durability. They last **5 times longer** than other brands thanks to the JBC Most Efficient Soldering System and the Sleep & Hibernation features.

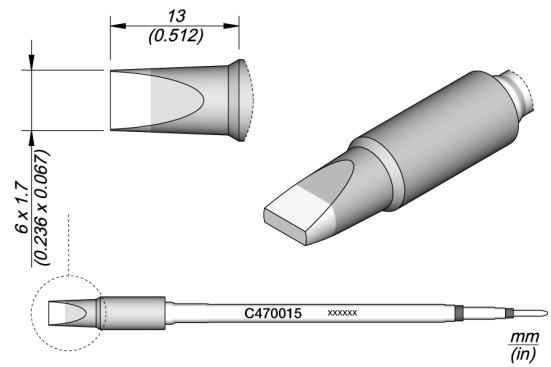

REFERENCES

C470015

SPECIFICATIONS

Net weight 0,02 kg (0.04lb)

WEIGHT AND DIMENSIONS

Package 183 x 60 x 34 mm / 0.03 kg
7.20 x 2.36 x 1.34 in / 0.06 lb